

Diritti riservati



All rights reserved

1

2

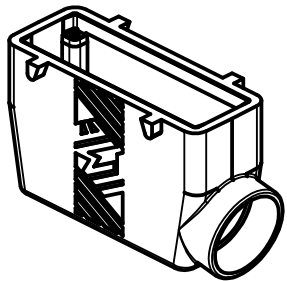
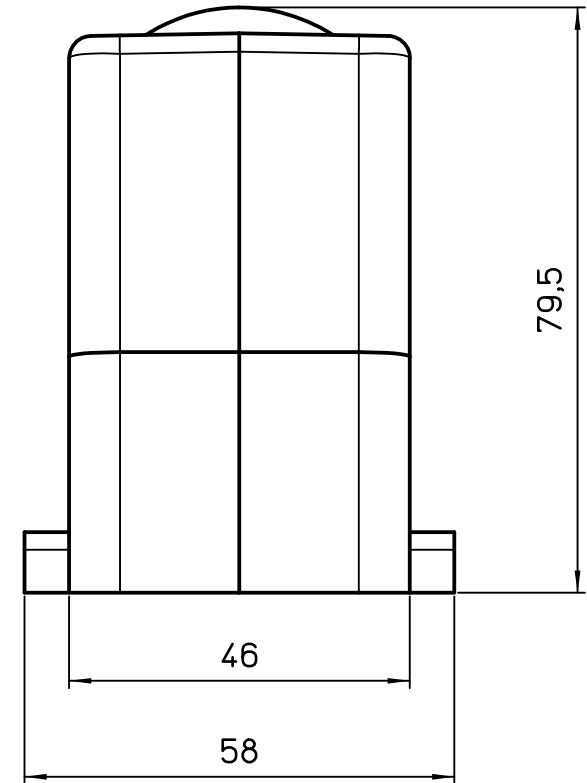
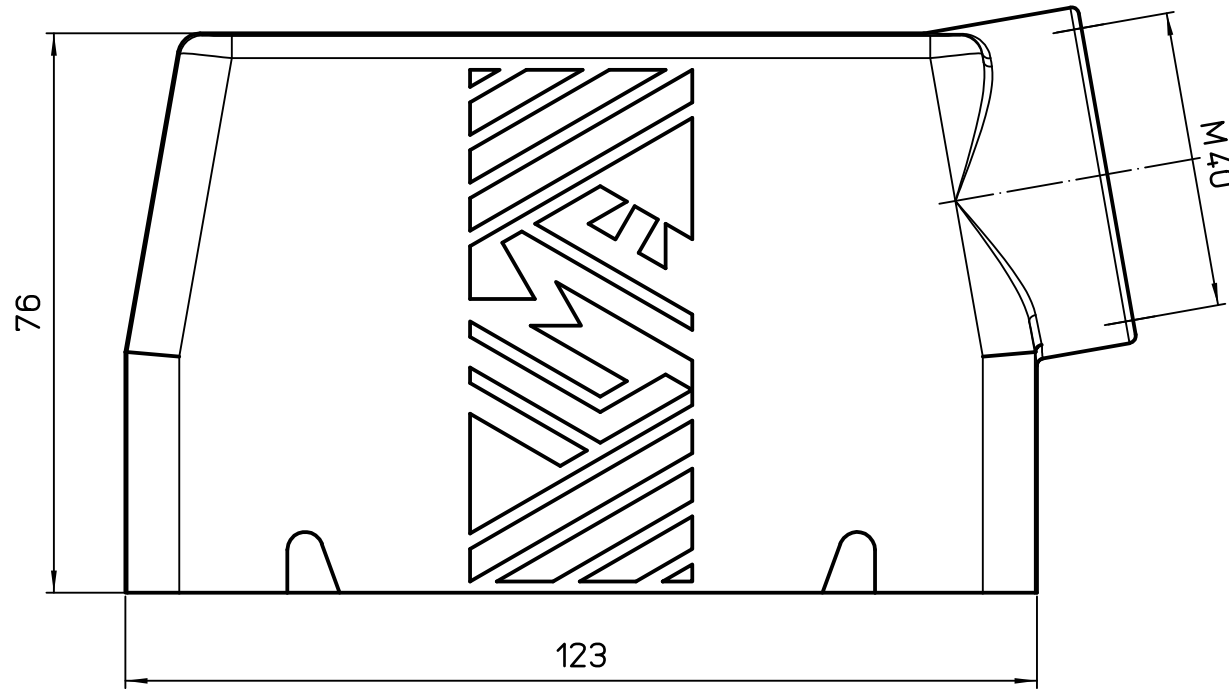
3



REV.	DATE	SIGNATURE		
			 Dimensione in mm	Simplified representation with dimensions without tolerance
			Original Size A4	TMAO 24.40B Insulating hood side entry M40 with P.E. jumper
			Date 23/06/20	
			Sign. B. Pitasi	
			Scale 1:1	

1

2

3